

**NOTES:**

1. EXISTING EQUIPMENT.
2. PERMISSIBLE TO TRIM PARTS CREATED BY THIS DRAWING ON INSTALLATION AS REQUIRED.
3. TOUCH UP ALL BARE ALUMINUM SURFACES WITH ALODINE PER MIL-C-5541 CLASS 3.
4. PARENTHETICAL ENTITIES, ( ), ARE FOR REFERENCE ONLY.
5. LOCATE CIRCUIT BREAKER IN THE SAME GENERAL AREA WITH EXISTING CIRCUIT BREAKERS. LABEL AS SHOWN USING STANDARD ENGRAVING, SILKSCREEN, OR OTHER TECHNIQUES. LETTERING TO BE SAME HEIGHT AS EXISTING C/B LETTERING.
6. - - - - DENOTES EXISTING WIRES.
7. GROUND TWISTED-PAIR POWER RETURN WIRE NEAR CIRCUIT BREAKER PANEL. TWISTED-PAIR TO BE 6 TURNS PER FOOT OR GREATER.
8. TIE INTO EXISTING BUS BAR NEAR LOCATION OF NEW CIRCUIT BREAKER. IF A JUMPER WIRE IS REQUIRED, USE 20 GAUGE MIL-W-22759/XX TYPE.
9. BEST COMMERCIAL EQUIVALENT MAY BE SUBSTITUTED FOR THIS PART.
10. THE INSTALLATION OF WIRING TO BE PERFORMED IN ACCORDANCE WITH AC 43.13-1B, 2A, ACCEPTABLE METHODS, TECHNIQUES, AND PRACTICES - AIRCRAFT ALTERATIONS, CHAPTER 11. ALL WIRE TO BE MIL-W-22759/16 OR EQUIVALENT.
11. LETTERING TO BE .10 HIGH MINIMUM, WHITE, HELVETICA, LOCATED APPROX AS SHOWN. USE STANDARD SILKSCREENING, ENGRAVING OR PLACARD TECHNIQUES.
12. OPTIONAL MOUNTING SCREW / MOUNTING HOLE.
13. SEE OWNERS MANUAL 03-353-201 FOR INSTALLATION CRITERIA.
14. SEE MFG INSTALLATION MANUAL FOR RS-232 HOOKUPS (OPTIONAL).
15. THE FOLLOWING IS A GUIDE FOR UNSWITCHED AUDIO PINOUTS. PINOUTS MUST BE VERIFIED WITH LATEST MANUFACTURER DRAWINGS.

REVISIONS			
REV	DESCRIPTION	DATE	APVD

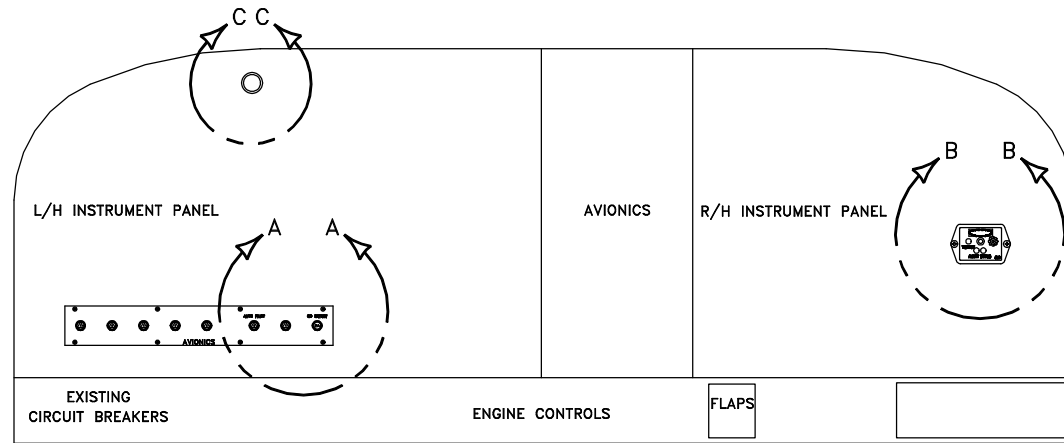

**TYPICAL INSTRUMENT PANEL**  
VIEW LOOKING FWD

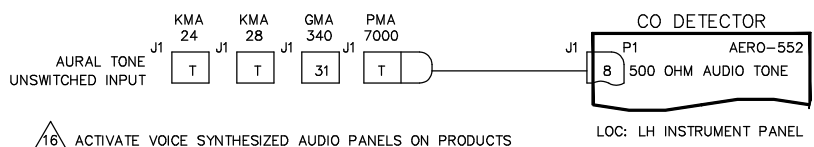

16. ACTIVATE VOICE SYNTHESIZED AUDIO PANELS ON PRODUCTS SUCH AS PS ENGINEERING MODEL PMA 7000B PIN 20.
17. OPTIONAL IF DETECTOR IS INSTALLED AWAY FROM THE PILOTS REACH OR INSTALLED IN A REMOTE APPLICATION.
18. SPARE GROUND USED BY GARMIN 900 AND G1000. SEE GARMIN INSTALLATION MANUAL.
19. MFD CONTROLLED BY RS232 REMOTE TEST/RESET.
20. TEMP OUTPUT (0-5V) SEE MFG INSTALLATION MANUAL.
21. CO OUTPUT (0-5V) SEE MFG INSTALLATION MANUAL.

ITEM	QTY	PART NUMBER	DESCRIPTION	VENDOR
6	3	205204-1	9 PIN D-SUB	AMP
5	3	MS35214-44	SCREW	QPL
4	1	164566	MOMENTARY SWITCH	DIGI KEY
3	1	855SI-A-3-DDS	LAMP	SOLAN
2	1	7277-2-2	CIRCUIT BREAKER	KLIXON
1	1	353-***	C O DETECTOR	C O GUARDIAN

<b>PROPRIETARY NOTICE</b> This drawing contains specifications and/or data, technical material, proprietary designs and information that are the sole property of C O Guardian, LLC, and is loaned to its recipient on a confidential basis, and is not to be shown or disclosed to any unauthorized organization or person.	RIVET CODES PER NAS203 BB = MS20426AD BJ = MS20470AD	UNLESS OTHERWISE NOTED ALL DIM ARE IN INCHES TOLERANCES .XXX ±.010 ANGLES .XX ±.03 ±1/2° .X ±.1	UNLESS OTHERWISE NOTED ALL DIM ARE IN INCHES TOLERANCES .XXX ±.010 ANGLES .XX ±.03 ±1/2° .X ±.1	
	UNLESS OTHERWISE NOTED: ALL BEND RAD TO BE 3 x MATL. THICKNESS	UNLESS OTHERWISE NOTED: ALL DIM ARE IN INCHES TOLERANCES .XXX ±.010 ANGLES .XX ±.03 ±1/2° .X ±.1	UNLESS OTHERWISE NOTED: ALL DIM ARE IN INCHES TOLERANCES .XXX ±.010 ANGLES .XX ±.03 ±1/2° .X ±.1	UNLESS OTHERWISE NOTED: ALL DIM ARE IN INCHES TOLERANCES .XXX ±.010 ANGLES .XX ±.03 ±1/2° .X ±.1
	UNLESS OTHERWISE NOTED: ALL DIM ARE IN INCHES TOLERANCES .XXX ±.010 ANGLES .XX ±.03 ±1/2° .X ±.1	UNLESS OTHERWISE NOTED: ALL DIM ARE IN INCHES TOLERANCES .XXX ±.010 ANGLES .XX ±.03 ±1/2° .X ±.1	UNLESS OTHERWISE NOTED: ALL DIM ARE IN INCHES TOLERANCES .XXX ±.010 ANGLES .XX ±.03 ±1/2° .X ±.1	UNLESS OTHERWISE NOTED: ALL DIM ARE IN INCHES TOLERANCES .XXX ±.010 ANGLES .XX ±.03 ±1/2° .X ±.1
	UNLESS OTHERWISE NOTED: ALL DIM ARE IN INCHES TOLERANCES .XXX ±.010 ANGLES .XX ±.03 ±1/2° .X ±.1	UNLESS OTHERWISE NOTED: ALL DIM ARE IN INCHES TOLERANCES .XXX ±.010 ANGLES .XX ±.03 ±1/2° .X ±.1	UNLESS OTHERWISE NOTED: ALL DIM ARE IN INCHES TOLERANCES .XXX ±.010 ANGLES .XX ±.03 ±1/2° .X ±.1	UNLESS OTHERWISE NOTED: ALL DIM ARE IN INCHES TOLERANCES .XXX ±.010 ANGLES .XX ±.03 ±1/2° .X ±.1
	UNLESS OTHERWISE NOTED: ALL DIM ARE IN INCHES TOLERANCES .XXX ±.010 ANGLES .XX ±.03 ±1/2° .X ±.1	UNLESS OTHERWISE NOTED: ALL DIM ARE IN INCHES TOLERANCES .XXX ±.010 ANGLES .XX ±.03 ±1/2° .X ±.1	UNLESS OTHERWISE NOTED: ALL DIM ARE IN INCHES TOLERANCES .XXX ±.010 ANGLES .XX ±.03 ±1/2° .X ±.1	UNLESS OTHERWISE NOTED: ALL DIM ARE IN INCHES TOLERANCES .XXX ±.010 ANGLES .XX ±.03 ±1/2° .X ±.1

DESIGN: ERIC WILSON DRAWN: SCOTT BILLINGS CHECK: SCOTT BILLINGS INSP: [ ] PROJ: [ ] REL: ASH VIJ	APPROVALS: [ ] DATE: 02/21/06 DATE: 02/21/06 DATE: 02/22/06	PART NUMBER: 353-001 DESCRIPTION: CO DETECTOR INSTL. VENDOR: C O GUARDIAN
---	--	---

**C O GUARDIAN** 1961 East Airport Drive  
 Tucson, AZ 85706  
 TITLE: CO DETECTOR INSTL.  
 DRAWING NO. 353-001  
 SCALE: NONE  
 SHEET 1 OF 7  
 REV 7 A

FILENAME: 353-001IR

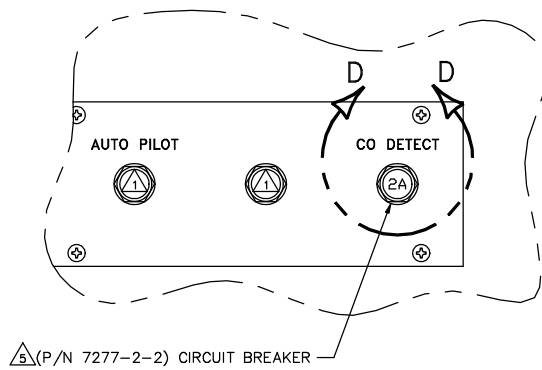

SECTION A-A

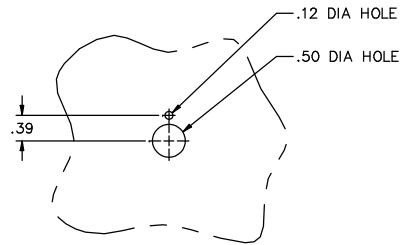

SECTION D-D  
C/B REMOVED FOR CLARITY

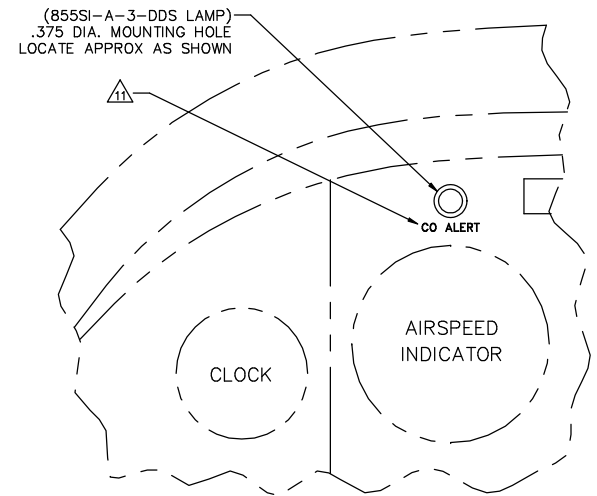

SECTION C-C

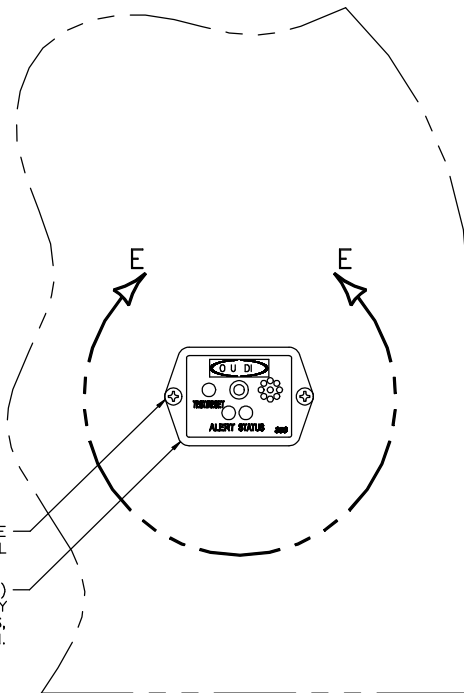

SECTION B-B

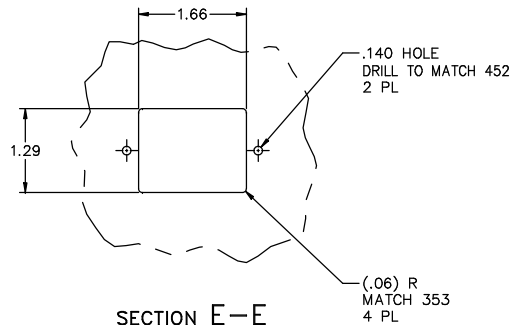

SECTION E-E  
353 REMOVED FOR CLARITY

**NOTE:**

OPTIONAL FLUSH MOUNT INSTALLATION: MOUNT 353 CO DETECTOR BEHIND MOUNTING HOLE IN INSTRUMENT PANEL.

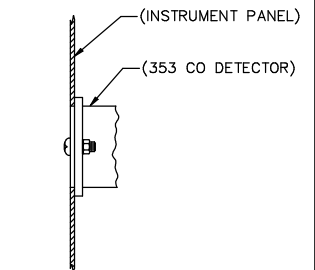
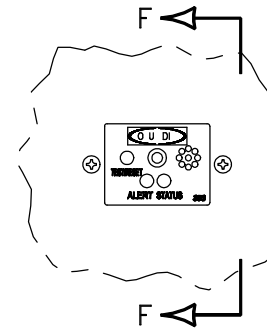

SECTION F-F

**CO GUARDIAN** 1061 East Airport Drive  
Tucson, AZ 85706

TITLE  
CO DETECTOR INSTL.

DRAWING NO. 353-001      SET 2 OF 7      REV 7 A

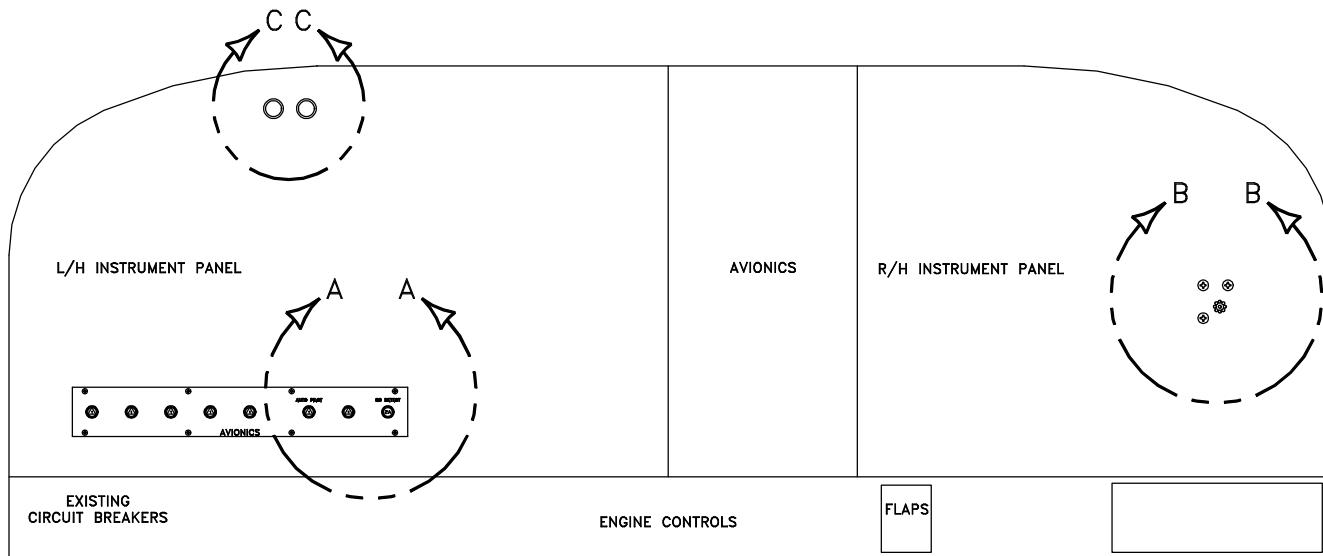

TYPICAL INSTRUMENT PANEL

VIEW LOOKING FWD

		1001 East Airport Drive Tucson, AZ 85706	
TITLE CO DETECTOR INSTL.			
DRAWING NO. 353-001	SET OF 7	REV. 3 A	REV. 7 A

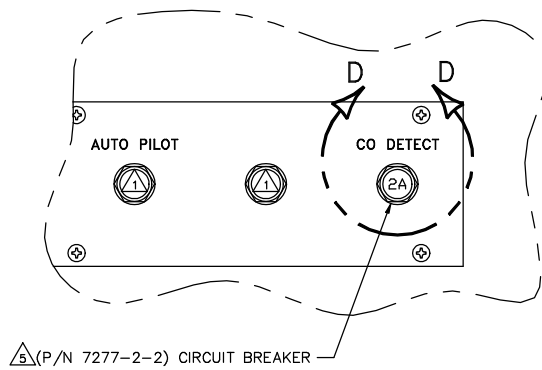

SECTION A-A

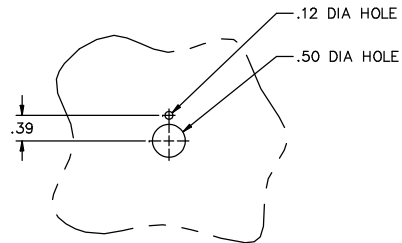

SECTION D-D  
C/B REMOVED FOR CLARITY

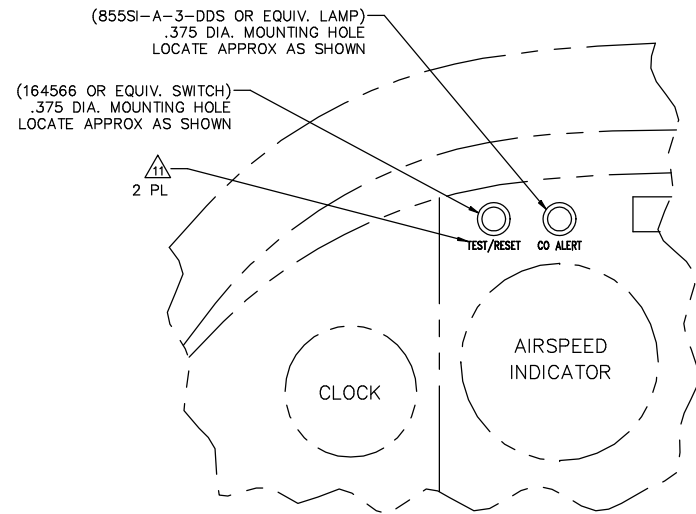

SECTION C-C

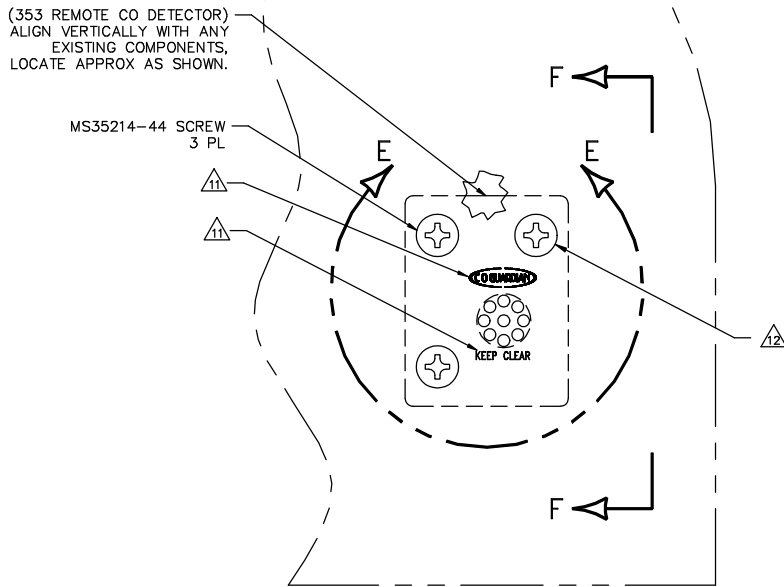

SECTION B-B

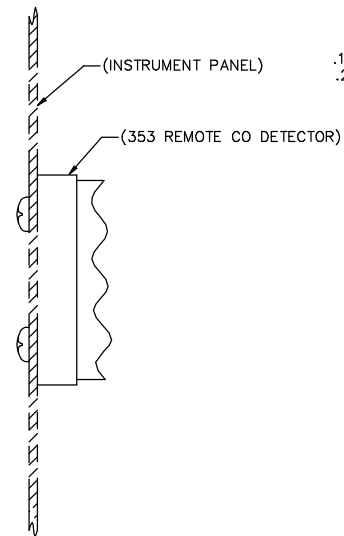

SECTION F-F  
→ FWD

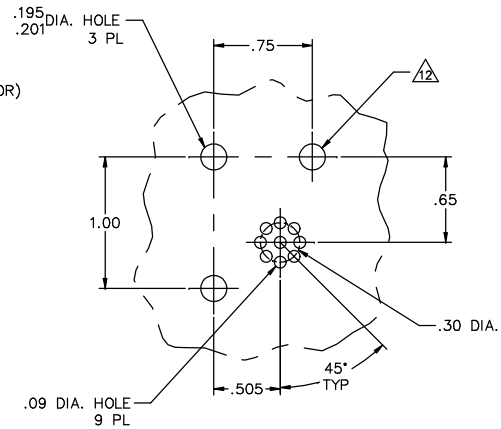

SECTION E-E  
MOUNTING HARDWARE REMOVED FOR CLARITY

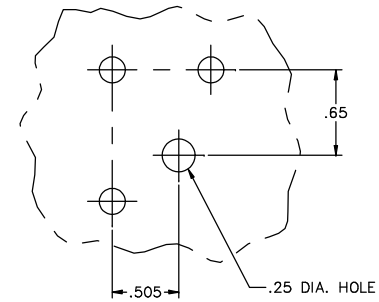

OPTIONAL HOLE PATTERN

<b>CO GUARDIAN</b>		1001 East Airport Drive Tucson, AZ 85706	
TITLE CO DETECTOR INSTL.			
DRAWING NO. 353-001	SH OF 4 7	REV A	

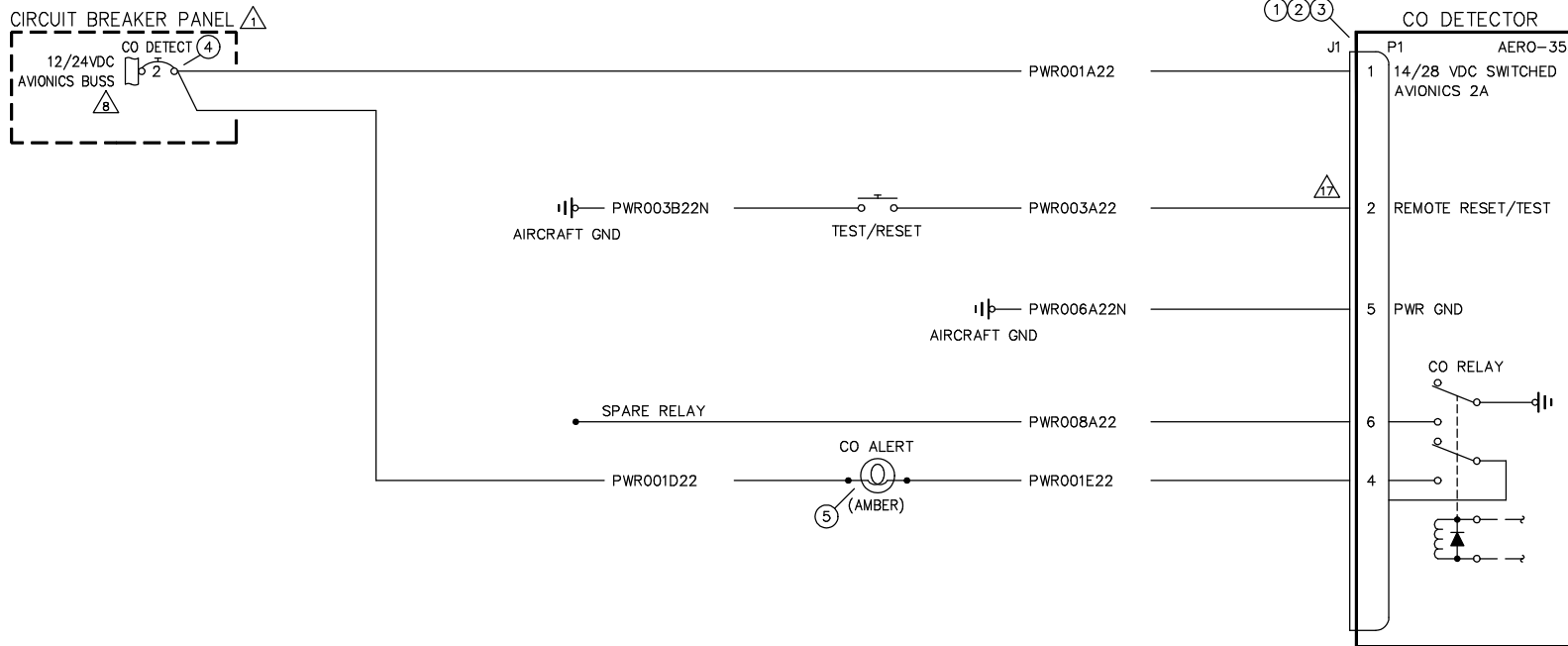

353-101 AND 353-201

<b>CO GUARDIAN</b>		1001 East Airport Drive Tucson, AZ 85706	
TITLE <b>CO DETECTOR INSTL.</b>			
DRAWING NO.	353-001	SHEET	REV
		5	A
		7	

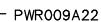
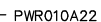
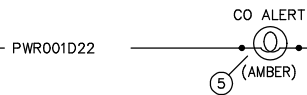
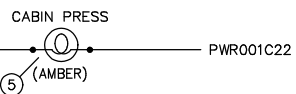
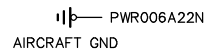
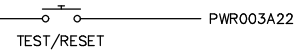
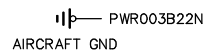
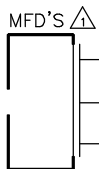
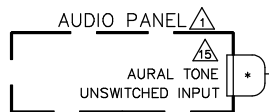
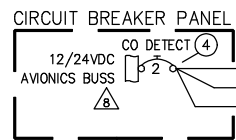

①②③

CO DETECTOR

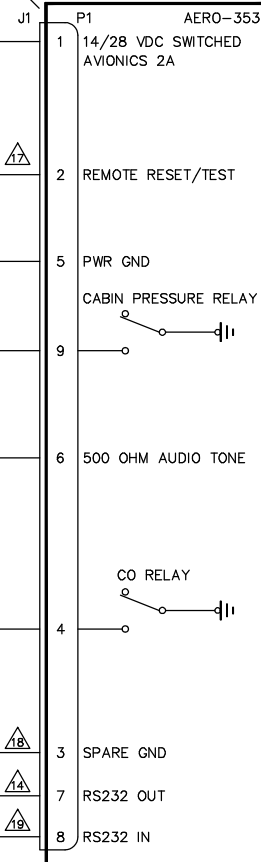

LOC: LH INSTRUMENT PANEL

C O DETECTOR INSTALLATION WIRING DIAGRAM

353P-101 AND 353P-201

<b>CO GUARDIAN</b>		1001 East Airport Drive Tucson, AZ 85706	
TITLE CO DETECTOR INSTL.			
DRAWING NO. 353-001	Sht OF 6 7	REV A	

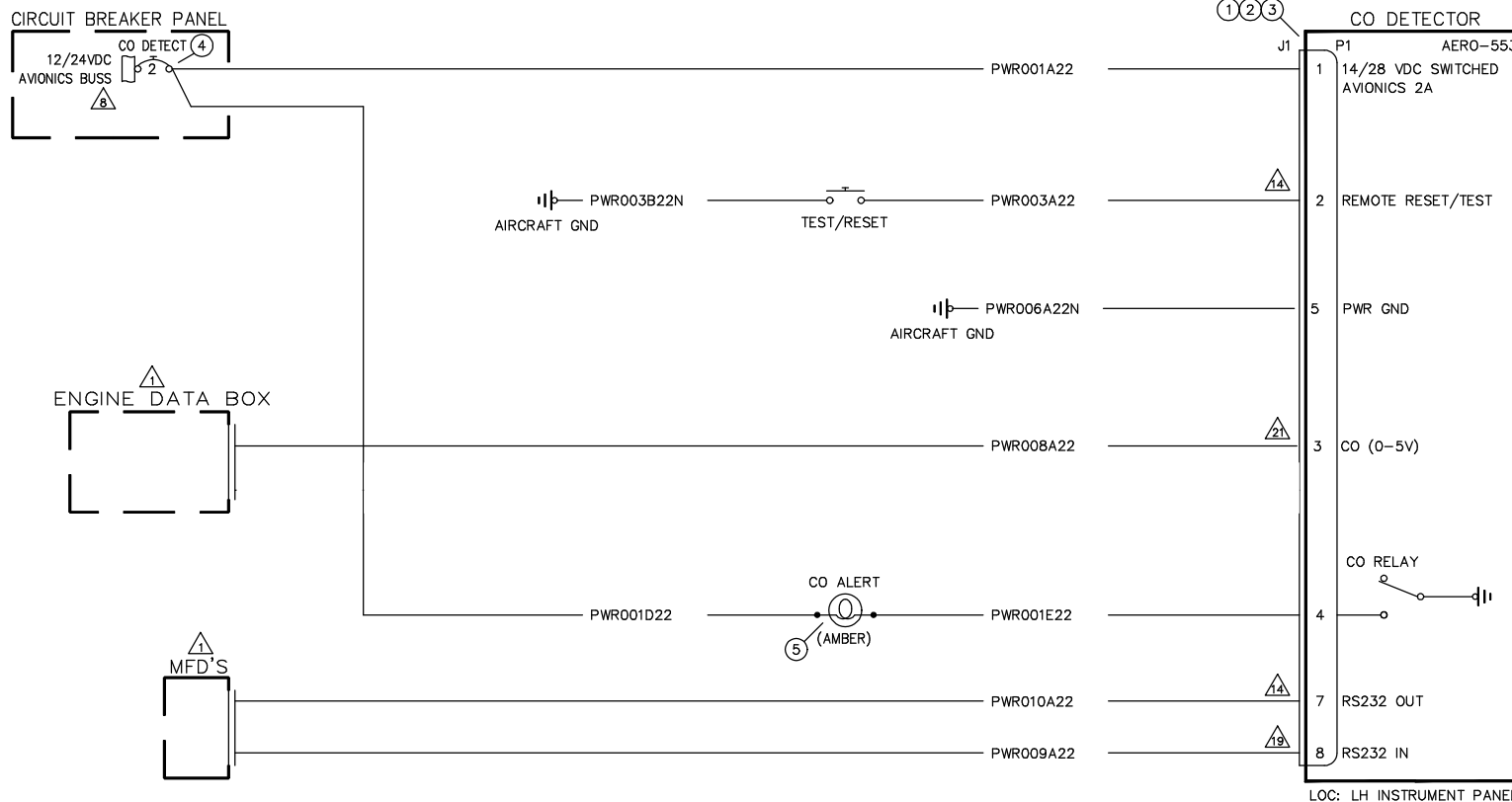

C O DETECTOR INSTALLATION WIRING DIAGRAM

353D-101 AND 353D-201

<b>CO GUARDIAN</b>		1061 East Airport Drive Tucson, AZ 85706	
TITLE CO DETECTOR INSTL.			
DRAWING NO. 353-001	Sht OF 7	REV 7	REV A