

Emergency Locator Transmitters

INSTALLATION MANUAL OPERATION MANUAL



ELT KANNAD 406 AF-COMPACT 406 AF-COMPACT (ER)

© KANNAD: This document is the property of KANNAD and contains proprietary and confidential information. The document is loaned on the express condition that neither the document itself nor the information contained therein shall be disclosed without the express consent of KANNAD and that the information shall not be used by the recipient without prior written acceptance by KANNAD. Furthermore, the document shall be returned immediately to KANNAD upon request.

**Users are kindly requested to notify KANNAD of any discrepancy,
omission or error found in this manual.
Please report to our customer support:
E-mail: support.sar@kannad.com
Tel.: +33 (0)2 97 02 49 00**

RECORD OF REVISIONS

REV. Nb	REVISION DATE	INSERTION DATE	BY
00	JUN 10/2008	JUN 10/2008	J.S.
01	MAR 02/2009	MAR 02/2009	J.S.
02	SEP 16/2009	SEP 16/2009	J.S.
03	MAY 05/2010	MAY 05/2010	J.S.

RECORD OF REVISIONS

PAGE INTENTIONALLY LEFT BLANK

LIST OF EFFECTIVE PAGES

SUBJECT	PAGE	DATE
Title Page		
TP	1	MAY 05/2010
Record of Revisions		
ROR	1	MAY 05/2010
ROR	2	MAY 05/2010
List of Effective Pages		
LEP	1	MAY 05/2010
LEP	2	MAY 05/2010
Table of Contents		
TOC	1	SEP 16/2009
TOC	2	SEP 16/2009
TOC	3	SEP 16/2009
TOC	4	SEP 16/2009
Introduction		
INTRO	1	SEP 16/2009
INTRO	2	SEP 16/2009
System Overview		
	1	SEP 16/2009
	2	SEP 16/2009
	3	SEP 16/2009
	4	SEP 16/2009
	5	SEP 16/2009
	6	SEP 16/2009
System Functional Description and Operation		
	101	SEP 16/2009
	102	SEP 16/2009

LIST OF EFFECTIVE PAGES

SUBJECT	PAGE	DATE
Installation / Removal	103	SEP 16/2009
	104	SEP 16/2009
	105	SEP 16/2009
	106	SEP 16/2009
	107	SEP 16/2009
	108	MAY 05/2010
	201	SEP 16/2009
	202	SEP 16/2009
Check	203	SEP 16/2009
	204	SEP 16/2009
	205	SEP 16/2009
	206	SEP 16/2009
	301	SEP 16/2009
	302	SEP 16/2009
Troubleshooting	303	SEP 16/2009
	304	SEP 16/2009
	401	SEP 16/2009
	402	SEP 16/2009
Schematics and Diagrams	501	SEP 16/2009
	502	SEP 16/2009
Servicing	601	SEP 16/2009

LIST OF EFFECTIVE PAGES

SUBJECT	PAGE	DATE
	602	SEP 16/2009
	603	SEP 16/2009
	604	SEP 16/2009

LIST OF EFFECTIVE PAGES

PAGE INTENTIONALLY LEFT BLANK

TABLE OF CONTENTS

INTRODUCTION	1
WARRANTY	2
Scope	2
Exclusion	2
SYSTEM OVERVIEW	1
COSPAS-SARSAT System	1
Description	1
World coverage with the COSPAS-SARSAT system	2
Operation	2
Environmental improvements of ELTs	2
KANNAD 406 ELT System Presentation	3
LINE REPLACEABLE UNITS	5
Transmitter	5
Bracket	6
Outside antenna	6
SYSTEM FUNCTIONAL DESCRIPTION AND OPERATION	101
Transmitter Functional Description	101
Transmission	101
Controls & Connectors	101
Working mode information	102
Off	102
Self-Test	102
Armed	103
On	103
Autonomy	104
KANNAD 406 AF-COMPACT (P/N S1840501-01)	104
KANNAD 406 AF-COMPACT (ER) (P/N S1840501-04)	104
Electrical interfaces	105
Transmitter Technical Specifications	106
Equipment limitations	106
Activation	107
Standby mode for automatic activation	107
Manual activation	107
Off	107
Self-Test	107
Compatibility list	108
Mounting brackets	108
Remote control panels (RCP)	108
DIN-12 connector or programming dongles	108
Outside antennas	108
INSTALLATION / REMOVAL	201
Registration	201
General	201

TABLE OF CONTENTS

Registration in USA	201
Registration in Canada	202
Programming	203
"Pin programming" option	203
ELT transmitter installation procedure	204
ELT transmitter Connection	206
First power up	206
Removal	207
CHECK	301
Self-test	301
Periodicity	301
Self-test procedure	301
Operational tests	302
ELT operational tests	302
406 and 121.5 MHz transmission test	302
406 MHz	302
121.5 MHz	303
TROUBLESHOOTING	401
General	401
Faults on Self-test	401
Visual Indicator	401
3+1 flashes	401
3+2 flashes	401
3+3 flashes	401
3+4 flashes	401
SCHEMATICS & DIAGRAMS	501
ELT Outline Dimensions	501
KANNAD 406 AF-COMPACT, axis of installation	502
SERVICING	601
Maintenance Schedule	601
Periodic inspection	601
Proper installation	601
Operation of the control crash sensor	601
Transmitted signals	601
Batteries corrosion	602
Check of 121.5 MHz frequency	602
6-year inspection	602
Visual control of the housing and accessories	602
Operation of the controls and crash sensor	602
Measurement of output powers, frequencies and verification of digital message	602
Current draw measurement in ARM and ON positions (optional)	603
Battery pack replacement	603
Check of 121.5 MHz frequency	603
Battery replacement requirements	604

INTRODUCTION

The KANNAD 406 AF-COMPACT has been designed to satisfy the requirements of general aviation pilots, built on the long experience of KANNAD ELTs in 406 MHz technology in aviation, maritime and land distress beacons.

The KANNAD 406 AF-COMPACT (ER) ELT is an evolution of KANNAD 406 AF-COMPACT ELT. The main evolution consists in the extension to -40°C of temperature range.

The capability to connect either a 3-wire or 2-wire RCP is also applied to the KANNAD 406 AF-COMPACT and 406 AF-COMPACT (ER).

The instructions in this manual provide the information necessary for the installation and the operation of KANNAD 406 AF-COMPACT and 406 AF-COMPACT (ER) ELTs.

Servicing instructions of ELT are normally performed by shop personnel. For detailed instructions and identification parts list, refer to CMM 25-63-03.

For the initial installation, please refer to Initial Installation Manual supplied with KANNAD 406 AF-COMPACT and 406 AF-COMPACT (ER) ELTs.

FOR REGULATORY REQUIREMENTS, PLEASE CONSULT YOUR NATIONAL AVIATION AUTHORITY.

WARRANTY

1. Scope

The equipment is warranted against all material or manufacturing defect for a period of two years from the date of installation on the aircraft or thirty months for the date of shipment from KANNAD S.A.S. Z.I. des Cinq Chemins BP23, 56520 Guidel, France, whichever occur first.

Work carried out under the warranty shall not have the effect of extending the warranty period.

In respect of this warranty, after a defect has been noted by our services, the sole obligation incumbent upon us shall be the repair of the equipment or the element identified as being defective by our services or possibly its replacement free of charge, to the exclusion of all compensation or damages.

This warranty covers the cost of parts and labour in our factories.

The cost of transportation of the equipment replaced or repaired are the purchaser's exclusive responsibility.

The risks shall be borne by the purchaser.

2. Exclusion

Defects and deterioration caused by natural wear of the product or by external accident (poor maintenance, abnormal conditions of use, etc.) or by modification of the equipment and tools not recommended nor specified by our company, are excluded from the warranty.

Also the warranty shall not cover visible defects which the purchaser wouldn't have formally notified KANNAD within 48 hours of receipt of the equipment.

SYSTEM OVERVIEW

1. COSPAS-SARSAT System

A. Description

Launched in the early eighties by the four founder countries (Canada, France, Russia, USA), the COSPAS-SARSAT system provides satellite aid to search and rescue (SAR) operations for maritime, aeronautical and terrestrial vehicles anywhere in the world.

It uses distress beacons fitted on mobiles and a constellation of LEO and GEO satellites which relay and process the 406 MHz signal to ground stations (LUT) where the beacon positions are determined with a precision of less than 2 NM.

Several types of beacons are designed to match the various applications of the COSPAS-SARSAT system:

- EPIRB (Emergency Position Indicating Radio Beacon) for maritime applications.
- ELT (Emergency Locator Transmitter) for aeronautical applications.
- PLB (Personal Locator Beacon) for land expeditions.

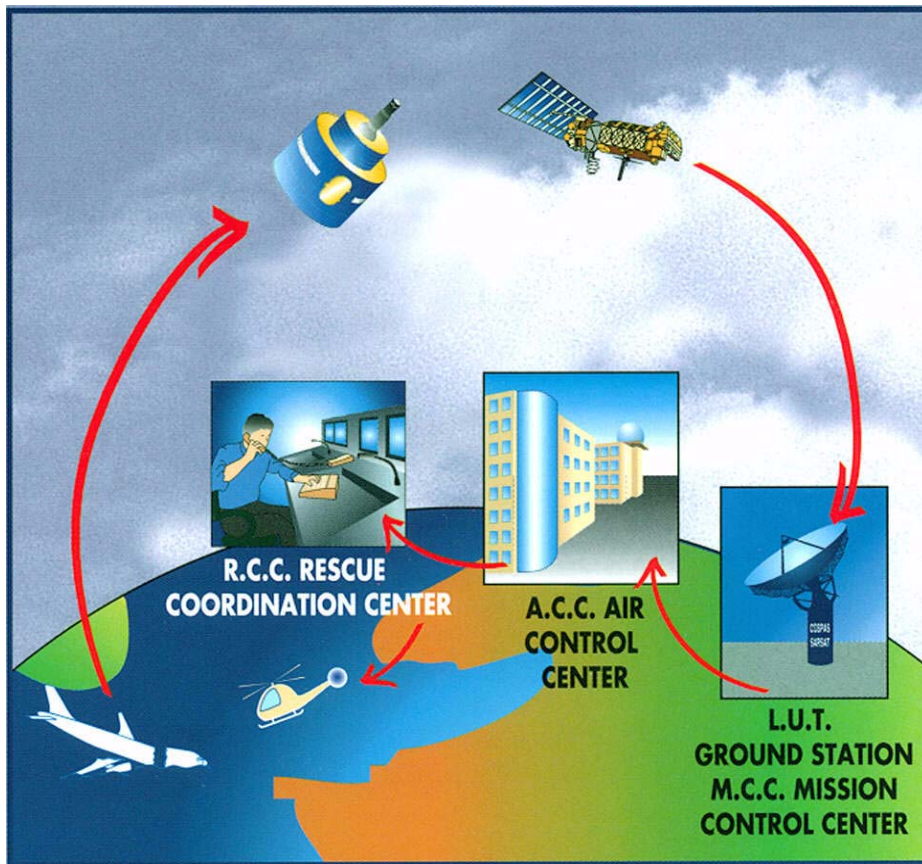

Figure 1: COSPAS-SARSAT System

B. World coverage with the COSPAS-SARSAT system

The major improvement is the use of the COSPAS-SARSAT system for processing aeronautical emergencies.

The 406 MHz transmission carries digital data which enable the identification of the aircraft in distress and facilitate SAR operation (type of the aircraft, number of passengers, type of emergency).

The 406 MHz message is transmitted to the COSPAS-SARSAT satellites. This message is downloaded to one of the 64 ground stations (44 LEOLUTs and 20 GEOLUTS).

The aircraft is located by Doppler effect by the LEO satellites with a precision better than 2 NM (4 km) at any point of the earth.

The 121.5 MHz frequency is no more processed by COSPAS-SARSAT system but is still used by SAR services for homing in the final stage of rescue operations.

C. Operation

In the event of a crash, the ELT activates automatically and transmits a sweep tone on 121.5 MHz and the 406 MHz signal.

In a crash, a G-Switch (shock detector) turns the ELT "ON" when the ELT is subjected to an important change of velocity (or deceleration).

Activation may also be accomplish by means of a Remote Control Panel (RCP) from the cockpit or directly from a switch of the ELT's front panel.

D. Environmental improvements of ELTs

The certification of an ELT includes a range of severe mechanical tests:

- resistance to flame;
- impact and crush tests;
- resistance to 100 G and 500 G shocks;
- watertightness;
- anti-deflagration;
- extreme temperatures .

2. KANNAD 406 ELT System Presentation

KANNAD 406 AF-COMPACT and 406 AF-COMPACT (ER) belong to the AF type of ELTs which are permanently attached to an aircraft. The KANNAD 406 AF-COMPACT is designed to be installed on fixed wing aircraft or helicopters. The KANNAD 406 AF-COMPACT ELT system ([Refer to Section Figure 2: ELT system description page 4](#)) is composed of:

1. the ELT transmitter:
 - P/N S1840501-01 for KANNAD 406 AF-COMPACT or,
 - P/N S1840501-04 for KANNAD 406 AF-COMPACT (ER).
2. a mounting bracket (P/N S1840502-01 or S1840502-02);
3. an outside whip or rod antenna;
4. A remote control panel⁽¹⁾;
5. a DIN-12 connector or programming dongle when the optional RCP is connected.

Note: (1) **The RCP is optional only if the commands and controls of the ELT are reachable and visible from the pilot seated position.**

(RTCA DO-204A):

*"Equipment control and indicator installed for in-flight use **shall** be readily accessible from the cockpit crew position. The cockpit crew **shall** have an unobstructed view of visual indicator when in the normal seated position."*

For details of approved part number of KANNAD 406 AF-COMPACT system, [Refer to Section 6. Compatibility list page 108.](#)

The transmitter and bracket are installed in the aircraft near the tail. The outside antenna is mounted on the fuselage near the tail. The remote control panel is installed in the cockpit and connected to the ELT with a DIN-12 connector or a programming dongle and a 2 or 3-wire bundle (not supplied)

IMPORTANT: Only transmitters P/N S1840501-01 at amendment M or higher and transmitters P/N S1840501-04 are compatible with 2-wire RCP such as an RC102.

CAUTION: If a transmitter P/N S1840501-01 at amendment M or higher should be replaced by a transmitter P/N S1840501-01 at amendment L or lower, check that it is not connected to a 2-wire RCP such as an RC102.

Figure 2: ELT system description

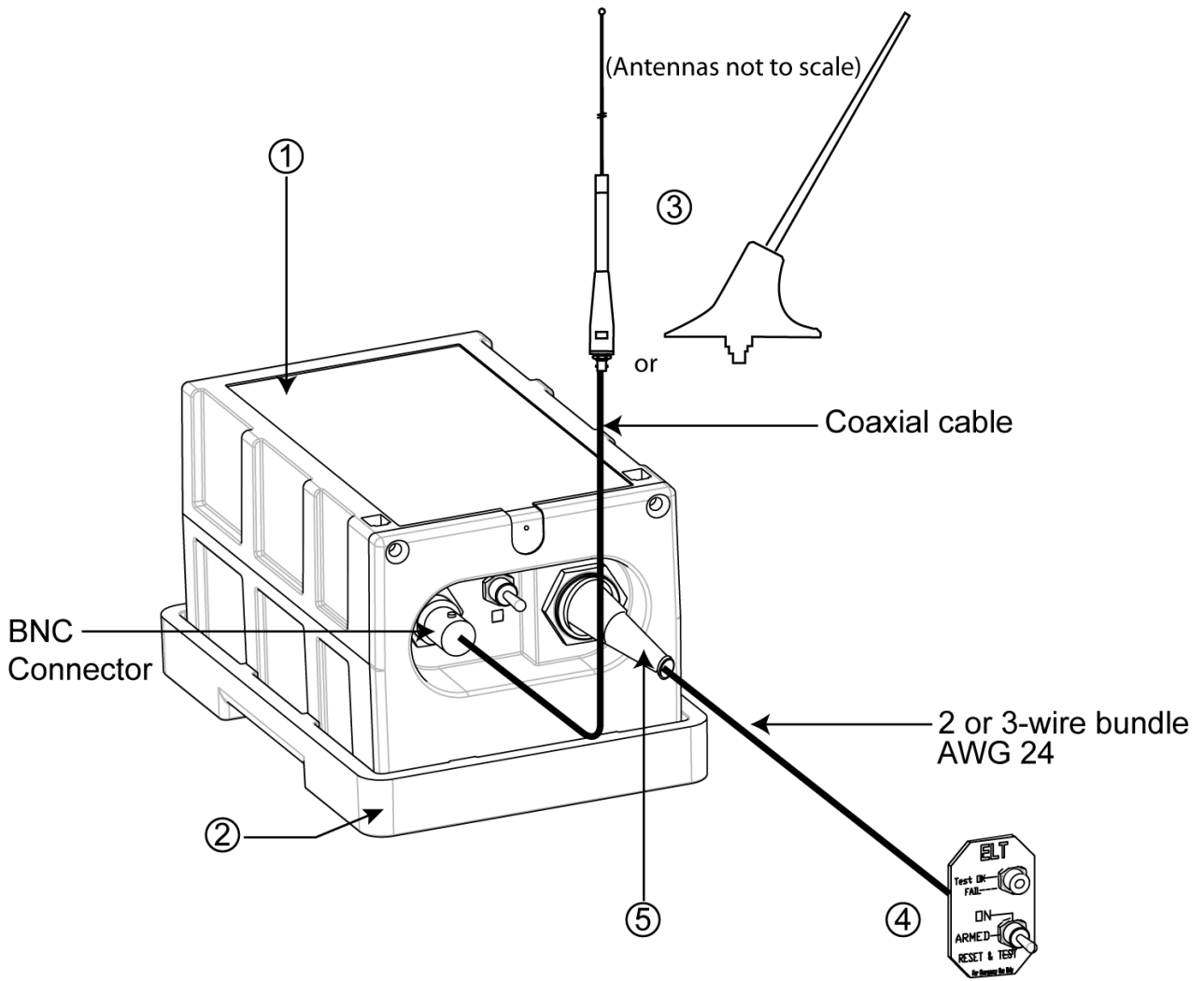

3. LINE REPLACEABLE UNITS

A. Transmitter

The KANNAD 406 AF-COMPACT and 406 AF-COMPACT (ER) are ELTs designed to be installed onboard aircraft to transmit a distress signal on frequencies:

- 406 MHz (COSPAS-SARSAT frequency) for precise pinpointing and identification of the aircraft in distress.
- 121.5 MHz used for homing in the final stages of the rescue operations.

The KANNAD 406 AF-COMPACT and 406 AF-COMPACT (ER) are certified as Automatic Fixed (AF) ELTs with the approved outside antennas.

The housing of KANNAD 406 AF-COMPACT and 406 AF-COMPACT (ER) transmitters are made of moulded plastic with excellent mechanical resistance.

The ELT housing is designed with no sharp edges.



Figure 3: ELT Transmitter

B. Bracket

The bracket installed near the tail is designed to fix the ELT with a Velcro® strap. This enables quick removal of the ELT for maintenance or exchange.



Figure 4: ELT Transmitter with Mounting Bracket

The transmitter may be installed on its standard mounting bracket (P/N S1840502-01) or on an Universal Mounting Bracket (P/N S1840502-02) to re-use existing drilling for retrofit (Refer to DOC07089, Initial Installation Manual) for drilling masks and outline dimensions of these brackets.

C. Outside antenna

Only approved antennas may be installed (Refer to Section 6. Compatibility list page 108).

Connection to the ELT will be carried out with a 50 Ohm coaxial cable (RG58 for example) ended with a male BNC connector.

IMPORTANT NOTICE: KANNAD recommends a cable with radio electric properties similar or better to those of a RG58 cable. The maximum permitted attenuation in the coaxial is 1 db at 400 MHz.

Note: the 50 Ohm coaxial and the male BNC connector are not supplied

SYSTEM FUNCTIONAL DESCRIPTION AND OPERATION

1. Transmitter Functional Description

A. Transmission

The transmitter can be activated either automatically when the crash occurs (thanks to a shock sensor) or manually (thanks to a switch on the transmitter itself or on a RCP).

The transmitter is designed to transmit on two frequencies (121.5 and 406 MHz). The 121.5 Mhz is mainly used for homing in the final stages of the rescue operations. The 406 MHz frequency is used by the COSPAS-SARSAT satellites for precise pinpointing and identification of the aircraft in distress.

Once activated, the transmitter operates continuously on 121.5 MHz with an output power of 100 mW. The modulation is an audio frequency sweeping downwards from 1420 Hz to 490 Hz with a repetition rate of 3 Hz.

During operations, a digital message is transmitted on 406.028 MHz every 50 seconds. The output power on 406 MHz is 5 W typical.

B. Controls & Connectors

The following controls are to be found on the ELT front panel (from left to right):

1. 3-position switch ARM/OFF/ON;
2. Visual indicator (red);
3. DIN 12 socket for connection to an optional Remote Control Panel, a programming dongle or a programming equipment;
4. BNC connector for the antenna.

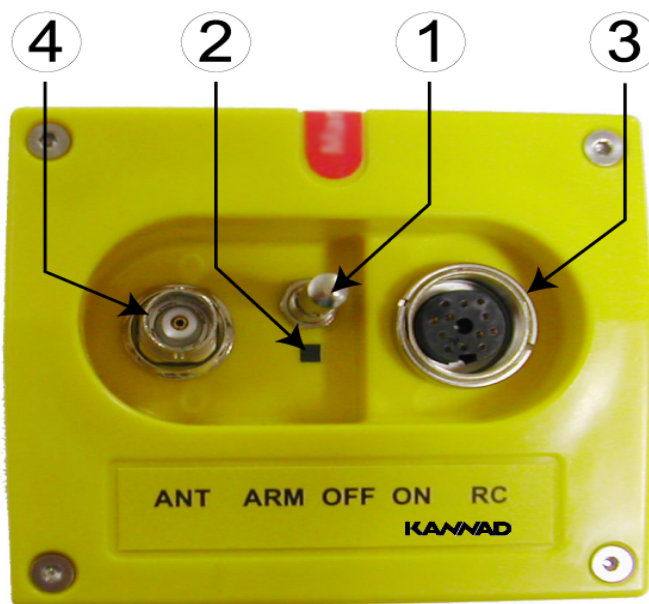

Figure 201: Front Panel

The red light gives an indication on the working mode of the beacon:

- after the self test:
 - a series of short flashes indicate the self test failed;
 - one long flash indicates a correct self test;
- in operating mode:
 - periodic flashes during 121.5 transmission;
 - long flash during 406 transmission.

A buzzer gives audio information on the beacon working:

- continuous tone during self test;
- 2 beeps per second during 121.5 transmission;
- silence during 406 transmission.

C. Working mode information

The ELT has 4 different modes:

- Off.
- Self-test (temporary mode).
- Armed (standby mode to enable automatic activation by the shock sensor or by an optional remote control panel).
- On (transmission).

Transmission is effective if the beacon is activated (either manually on the ELT control panel, automatically by the shock sensor, or remotely by the "ON" switch of an optional remote control panel when connected).

(1) Off

The ELT is off when the switch is in position "OFF", no part of the ELT is energized.

This mode must **only** be selected when the ELT is removed from the aircraft or when the aircraft is parked for a long period or for maintenance.

(2) Self-Test

The self-test mode is a temporary mode (max duration 15 sec) in which the ELT checks the main characteristics of the transmitter (Battery voltage, Programming...) and enables digital communication with programming and test equipment.

This mode is selected:

- when switching from "OFF" to "ARM";
- when switching to "RESET / TEST" on an optional Remote Control Panel (provided that the switch of the ELT is in position "ARM");
- when switching to "ON" prior to transmission.

The buzzer operates during the self-test procedure.

After about 10 seconds, the test result is displayed on the visual indicator as follows:

- One long flash indicates valid test.
- A series of short flashes indicates false test result.

The number of flashes indicates the type of failure:

- 3 + 1 = LOW BATTERY VOLTAGE.
- 3 + 2 = LOW TRANSMISSION POWER.
- 3 + 3 = FAULTY VCO LOCKING (FAULTY FREQUENCY).
- 3 + 4 = NO IDENTIFICATION PROGRAMMED.

It is recommended to test the ELT regularly in order to detect any possible failure ([Refer to A. Periodicity, page 301](#)).

The number of self-tests carried out is recorded. This information is available when the ELT is connected to a programming and test equipment (PR600).

(3) Armed

In order to enable activation by the G-Switch or with an optional Remote Control Panel, the ELT must be in standby mode with the switch in the "ARM" position.

This mode is mandatory during flight. The ELT should remain in the "ARM" position except when the aircraft is parked for a long period or for maintenance.

(4) On

This mode is selected:

- manually by switching the ELT to "ON";
- by switching an optional Remote Control Panel switch to "ON" (provided that the ELT switch is in the "ARM" position);
- automatically when a crash occurs (provided that the ELT switch is in the "ARM" position).

When this mode is selected, the ELT starts transmitting after 50 seconds:

- on 406 MHz (one 406 MHz burst every 50 seconds);
- on 121.5 MHz (continuous transmission between each 406 MHz burst).

The red visual indicator on the ELT (and on an optional remote control panel when connected) flashes and the buzzer operates.

- Red visual indicator:
 - 1 short flash during ELT transmission on 121.5 MHz (every 0.7

seconds);

- 1 long flash during ELT transmission on 406 MHz (every 50 seconds).
- Buzzer:
 - 1.5 Hz pulse signal (recurrence 0.7 s) during ELT transmission on 121.5 MHz.

In case of accidental activation, the ELT can be reset either by switching it to "OFF" or by switching to "RESET" on an optional Remote Control Panel when connected.

The number of 406 MHz bursts transmitted is recorded. This information is available when the ELT is connected to a programming and test equipment (PR600).

D. Autonomy

The energy is provided by a battery pack composed of a LiMnO₂ two-element battery (See pages 106 & 604 for Kit battery reference).

Lithium cells, lithium batteries and equipment containing such batteries are subjected to regulations and classified under class 9 as from 1st of January 2003.

The transmitter battery expiry date is fixed at 6 years after manufacturing. If no activation of the ELT occurs during the battery lifetime, it shall be replaced 6 years after date of manufacture^(see note below).

NOTE: The useful life time of batteries is twelve (12) years. To be in compliance with FAR regulations, they have to be replaced six (6) years after date of manufacture when 50 percent of their useful life has expired.

(1) KANNAD 406 AF-COMPACT (P/N S1840501-01)

The duration of the 121.5 transmissions is over 48 hours at -20°C.

Unlike other ELTs, the 406 MHz transmission of KANNAD 406 AF-COMPACT is not stopped after 24 hours and 406 MHz transmission is continuing beyond 48 hours.

(2) KANNAD 406 AF-COMPACT (ER) (P/N S1840501-04)

The duration of the 121.5 transmissions is over 48 hours at -40°C.

As it is therefore preferable to keep the battery power for 121.5 MHz homing frequency transmission for the rescue operations, in compliance with COSPAS-SARSAT specifications, the 406 MHz transmission is deliberately stopped after 24 hours to extend the 121.5 MHz transmission for as long as possible.

E. Electrical interfaces

J1

DIN 12 socket J1 is dedicated for connection to an optional Remote Control Panel, to a Programming or Maintenance Dongles or to a programming equipment (PR600).

IMPORTANT: Shielded cables are recommended. The required wires are AWG24.

J1	PIN	Signal Name	Destination	Direction
<p style="text-align: center;">Viewed from Front Face</p>	J1-A	RCP TEST/RESET	RCP	IN
	J1-B	DONGLE RX	SMM / PGM	IN
	J1-C	DONGLE CS	SMM	OUT
	J1-D	DONGLE SK	SMM	OUT
	J1-E	DONGLE TX	SMM / PGM	OUT
	J1-F	DONGLE ALE2P	SMM	OUT
	J1-G	RCP COMMON	RCP	OUT
	J1-H	RCP BUZZER	Not used	
	J1-J	RCP LED	RCP	OUT
	J1-K	RCP	RCP	OUT
	J1-L	DONGLE GND	SMM / PGM	OUT
	J1-M	COMMON	RCP	OUT

Table 1: J1 connector pin-out

J2

BNC female connector J2 is used to connect the outside antenna through a 50 Ω coaxial cable.

IMPORTANT NOTICE: The length of the coaxial cable should not exceed 2.7 meters (9 ft) for a standard RG58 or equivalent coaxial cable. If the cable length exceeds 2.7 meters, a low loss cable of attenuation less than 1 dB@400 MHz must be used (See Important notice Section C. Outside antenna, page 6).

F. Transmitter Technical Specifications

TYPE

- Two-frequency ELT (121.5 / 406.028 MHz)
- Automatic fixed
- COSPAS-SARSAT Class

COMPACT:

Class II, -20°C to +55°C.

COMPACT (ER):

Class I, -40°C to +55°C.

406 MHz TRANSMISSION

- Frequency: 406.028 MHz+/-1 kHz
- Output power: 5W (37 dBm +/- 2 dB)
- Modulation type: 16K0G1D (Biphase L encoding)
- Transmission duration: 440ms (short message) every 50 s.
- Autonomy

COMPACT: over 48 hours @-20°C

COMPACT (ER): 24 Hours @-40°C

121.5 MHz TRANSMISSION

- Frequencies: 121.5 MHz +/- 6 kHz
- Output power: 100 to 400 mW (20dBm to 26 dBm)
- Modulation type: 3K20A3X
- Modulation rate: > 85 %
- Frequency of modulation signal: 1420 Hz to 490 Hz with decreasing sweep
- Autonomy

COMPACT: over 48 hours@-20°C.

COMPACT (ER):
over 48 hours@-40°C

CONTROLS

- ARM / OFF / ON switch
- DIN12 socket for RCP and pin programming option.
- Bright red visual indicator

- Buzzer

- BNC antenna connector

G-SWITCH SENSOR

Mechanical G-switch sensor compliant with EUROCAE ED62 specifications

BATTERY

KIT BAT200, P/N: S1840510-01

LiMnO₂ two-element battery for transmitter power supply

Replacement 6 years after date of manufacture

HOUSING

Material: Polycarbonate

Color: Yellow (color compounded)

Transmitter dimensions:

131 x 86 x 75.4 mm

(5.157 x 3.385 x 2.968 inches)

Overall dimensions with mounting

bracket: max 140 x 98 x 86.4 mm

(5.512 x 3.858 x 3.4 inches)

Weight including batteries:

- typical 850 gr. (1.874 lb);
- max 875 gr. (1.929 lb).

Tightness: O-ring

ENVIRONMENTAL CONDITIONS

RTCA DO-160E / EUROCAE Section 4 to 26:

C1X[ED62]A[ED62][SYLMC/

UG]EYXXXXZXXX[ZC]

[ED62]B[XXXXX]XXX[ED62]

QUALIFICATIONS

ETSO-2C91a & ETSO-2C126

TSO-C126

FOR USE OUTSIDE OF THE USA OR

EASA RULES, CONTACT YOUR

LOCAL CIVIL AVIATION AUTHORITY.

2. Equipment limitations

None

3. Activation

A. Standby mode for automatic activation

In order to be automatically activated by the crash sensor, the ELT must be in standby mode. This mode is mandatory during the flight. We recommend to switch off the ELT only when removed from the aircraft or when the aircraft is parked for a long period or for a maintenance operation.

- Check that the antenna is correctly connected.
- Switch to " ARM".

To operate the ELT with an optional Remote Control Panel, ensure that:

- The ELT switch is the "ARM" position .

B. Manual activation

- Check that the antenna is correctly connected.
- Switch to " ON " (either on the ELT or on an optional Remote Control Panel when connected):
 - The ELT starts with the self-test sequence then, after 50 sec., transmits on:
 - 406 MHz (one 406 MHz burst every 50 seconds);
 - 121.5 MHz (continous transmission between each 406 MHz burst).
 - During transmission, the buzzer operates and the red visual indicator flashes.

4. Off

It is possible to stop the ELT in case of unintentional activation:

- Switch to " OFF ".

Regulations state that no transmission must be interrupted unless every means are used to contact and inform the Air Traffic Controller of this action.

Important notice: As 406 MHz transmission is effective 50 seconds after the ELT activation, if it is switched off within this delay, no further radio contact will be necessary.

5. Self-Test

[Refer to 1. Self-test, page 301](#)

6. Compatibility list

A. Mounting brackets

Designation	Part Number
COMPACT MOUNTING BRACKET KIT	S1840502-01
COMPACT UNIVERSAL MOUNTING BRACKET KIT	S1840502-02

B. Remote control panels (RCP)

Designation	Part Number
RC100 KIT	S1820513-03
RC200	S1820513-11
RC200-NVG	S1820513-14
RC102 KIT	S1820513-21

C. DIN-12 connector or programming dongles

Designation	Part Number
DIN-12 connector	S1820514-03
Programming dongle	S1820514-01
Programming dongle Assy	S1820514-06

D. Outside antennas

KANNAD Designation	Manufacturer	KANNAD Part Number
ANT200	DAYTON GRANGER ELT 10-773-x	0145621
ANT300	CHELTON 1327-82	0124220
WHIP ANT AV200	RAMI AV-200	0146150
ROD ANT AV300	RAMI AV-300	0146151
ANT100 ^(See note)	PROCOM	0124206

NOTE: ANT100 is a non ETSO/TSO antenna. It may be used as auxiliary antenna if the ELT is used as portable equipment and if such a use is approved by local authorities.

INSTALLATION / REMOVAL**1. Registration****A. General**

The ELT must be registered prior to installation onboard.

When a 406 MHz ELT is installed in an aircraft, it is imperative that the aircraft owner register the ELT. Each 406 MHz ELT contains a unique identification code that is transmitted to the satellite. This helps the "Rescue Coordination Center" (RCC) determine whether an emergency has actually occurred. The unique identification permits accessing a data base.

The registration card available from the local registration authority must be completed and returned to this authority.

The "Programming Datasheet" (DIM00300) must be completed and returned to your distributor.

Any change of ownership shall also be declared and registered with the local registration authority and with the distributor.

B. Registration in USA

Mail or Fax your registration form to:

NOAA/SARSAT
NSOF, E/SP3
4231 Suitland Road
Suitland, MD 20746

or Save Time! Register your beacon online at:

www.beaconregistration.noaa.gov

All online registrations will be entered into the National 406 MHz Beacon Registration Database on the same day of entry. Registration forms received via postal mail will be entered within 2 business days of receipt. For online registrations, a confirmation letter with your completed registration information form will be sent immediately via e-mail or fax (if provided). Confirmation letters sent via postal mail should arrive within two weeks. Once your registration confirmation is received, please review all information. Any changes or updates to your registration information can be done via the internet, fax, e-mail or postal mail. If you do not receive your registration confirmation from NOAA on the same day you submit it over the internet or within two weeks if you submit it by postal mail, please call NOAA toll-free at: 1-888-212-SAVE (7283) or 301-817-4515 for assistance.

After initial registration (or re-registration) you will receive a NOAA Proof of

Registration Decal by postal mail. This decal is to be affixed to the beacon and should be placed in such a way that it is clearly visible. If for some reason you do not receive the registration decal within two weeks, please call NOAA toll-free at: 1-888-212-SAVE (7283) or 301-817-4515.

Failure to register, re-register (as required every two years), or to notify NOAA of any changes to the status of your 406 MHz beacon could result in penalties and/or fines being issued under Federal Law. The owner or user of the beacon is required to notify NOAA of any changes to the registration information at any time. By submitting this registration the owner, operator, or legally authorized agent declares under penalty of law that all information in the registration information is true, accurate, and complete. Providing information that is knowingly false or inaccurate may be punishable under Federal Statutes. Solicitation of this information is authorized by Title 47 - Parts 80, 87, and 95 of the U.S. Code of Federal Regulations (CFR). Additional registration forms can be found on the NOAA-SARSAT website at:

www.sarsat.noaa.gov or at: www.beaconregistration.noaa.gov

C. Registration in Canada

Beacon information is held in the Canadian Beacon Registry maintained by the National Search and Rescue Secretariat for use in search and rescue operations. Online access to the Registry is available for all beacon owners to register new beacons or to update their beacon information. You can add or update your beacon information by accessing the registry directly, sending in a completed registration form or by talking to one of our beacon registry representatives.

You can access the registry:

- online: www.canadianbeaconregistry.com
- by email: CBR@Sarnet.dnd.ca
- by fax: 1-613-996-3746
- by telephone: 1-800-727-9414 or 1-613-996-1616

The registration information must be updated when the aircraft ownership changes as per the Canadian Airworthiness Notice AN B029 (refer to following link):

http://www.nss.gc.ca/site/Emergency_Beacons/canadian_beacon_registry_e.asp

This information must be recorded on the ELT LOG SHEET (ref. DIM08013) supplied with the ELT, fields Programming Log.

Additional information and registration forms can be found on the Canadian NSS website at:

http://www.nss.gc.ca/site/cospas-sarsat/INTRO_e.asp

2. Programming

A. "Pin programming" option

The KANNAD 406 AF-COMPACT and 406 AF-COMPACT (ER) offer pin-programming capabilities to facilitate maintenance operations especially in the case of removals and/or replacement.

A special DIN 12 connector with a Serial Memory Module (called "Programming Dongle") is connected to the ELT when installed onboard. This Programming Dongle contains the identification information of the aircraft and remains onboard the aircraft. When an unprogrammed ELT is installed and connected to this Programming Dongle and the "ELT" is switched to "ARM", it automatically updates its own memory with the identification data contained in the Programming Dongle memory.

When the ELT is removed from the aircraft, it keeps its identification data.

For maintenance purposes, it is possible to delete the identification information of the ELT by connecting a "Maintenance Dongle" to the ELT. Any accidental transmission with this "maintenance dongle" will not involve SAR operation as the identification code transmitted is recognised by COSPAS-SARSAT as "not onboard".

When a maintenance dongle is connected:

- Country code is **227** (France).
- Protocol is **Test**.
- Identification number is **SI + 5 digits** (the last 5 digits of CSN number) or **K + 6 digits** (the 6 digits of the CSN number).

If the pin programming option is selected by the owner, the following equipment are required:

- a "Programming Dongle" on each aircraft;
- a "Maintenance Dongle" on each ELT spare.



Figure 1: Maintenance Dongle

3. ELT transmitter installation procedure

NOTE: Initial installation (bracket installation and first wiring is described in Initial installation manual, DOC07089 also supplied with the transmitter).

1. Mount the transmitter on the bracket "Flight direction" arrow pointed towards the front of the aircraft ([Refer to 2. KANNAD 406 AF-COMPACT, axis of installation, page 502](#)).
2. Slide the self-stripping strap through the buckle. **Ensure the buckle is correctly positioned (indifferently on right or left side of ELT) regarding the horizontal center line of ELT as shown Detail A.**

3. Fasten the self-stripping strap tightly.

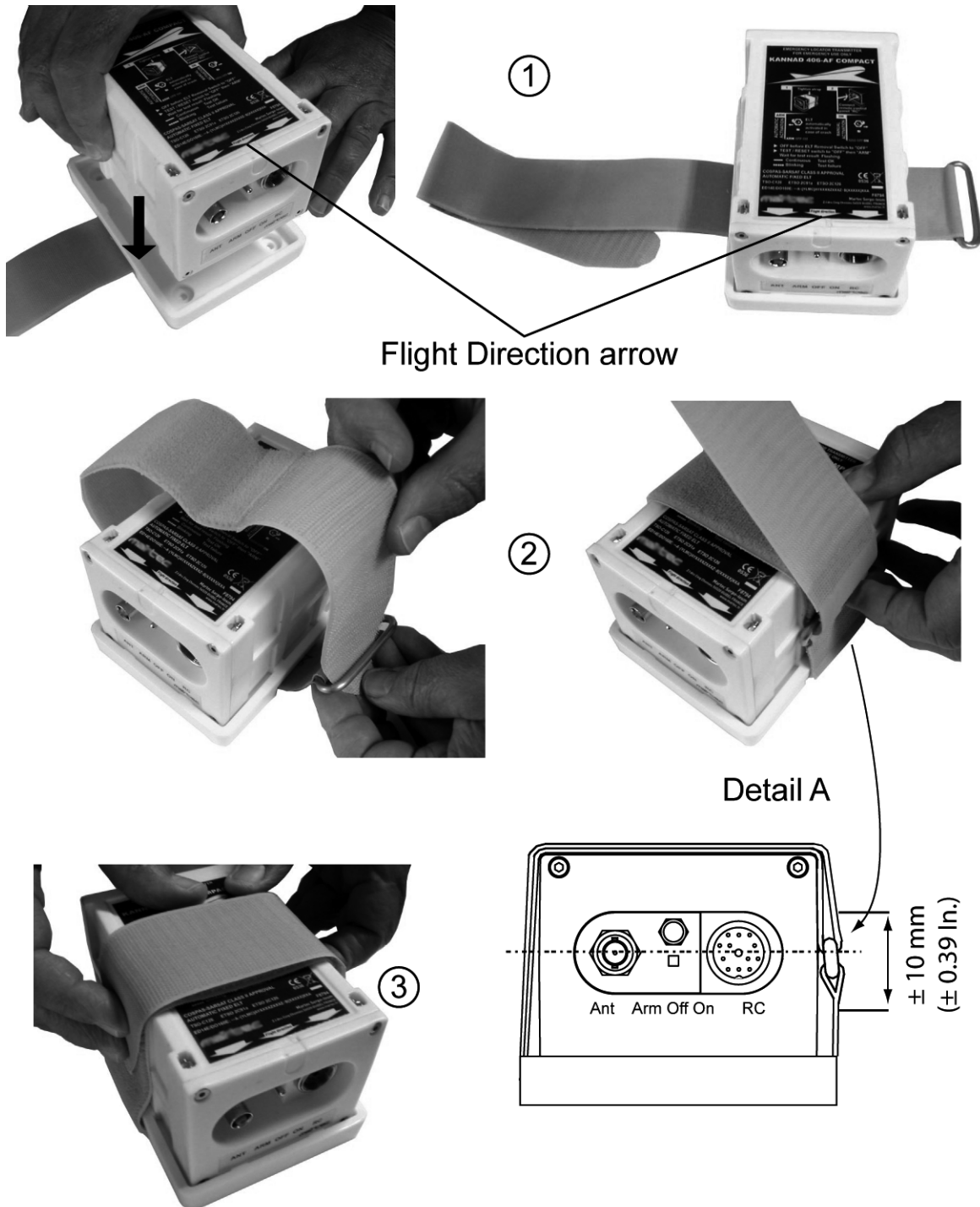

Figure 2: Installing the transmitter on the bracket

4. ELT transmitter Connection

1. Connect the cable of the outside antenna to the BNC connector of the front panel.
2. Set the 3-position switch of the front panel to ARM.

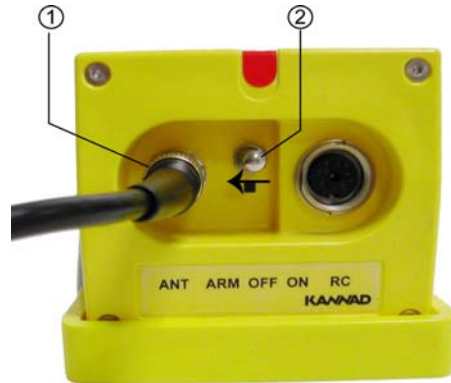

Figure 3: Installation, controls and connectors

- Perform the first power up procedure (see below).

5. First power up

Note: Antenna and RCP must be connected.

*Caution: never switch to ARM or ON if neither antenna cable nor 50 ohm load is connected to the ELT (1. BNC connector), **risk of ELT damage.***

Perform the following tests:

1. ELT operational tests:
 - connect the outside antenna to J2;
 - switch the ELT from OFF to ARM;
 - check that the Self-Test result is OK (one long flash).
2. 406 & 121.5 MHz transmission tests (optional):
[Refer to B. 406 and 121.5 MHz transmission test, page 302.](#)

At the end of the first power up procedure, switch the ELT to ARM.

The ELT is now in stand by mode and ready to be activated:

- either automatically by G-Switch sensor if a crash occurs;
- or manually by an optional Remote Control Panel (when connected).

Note : switching to ON directly on the ELT front panel will also activate the ELT.

6. Removal

1. Switch the ELT to OFF.
2. Disconnect the outside antenna from the BNC connector of the ELT.
3. If connected, disconnect the DIN 12 Connector of Remote Control Panel 2 or 3-wire bundle from the DIN12 socket of the ELT.
4. Unfasten the self-stripping strap.
5. Remove the transmitter from the bracket.

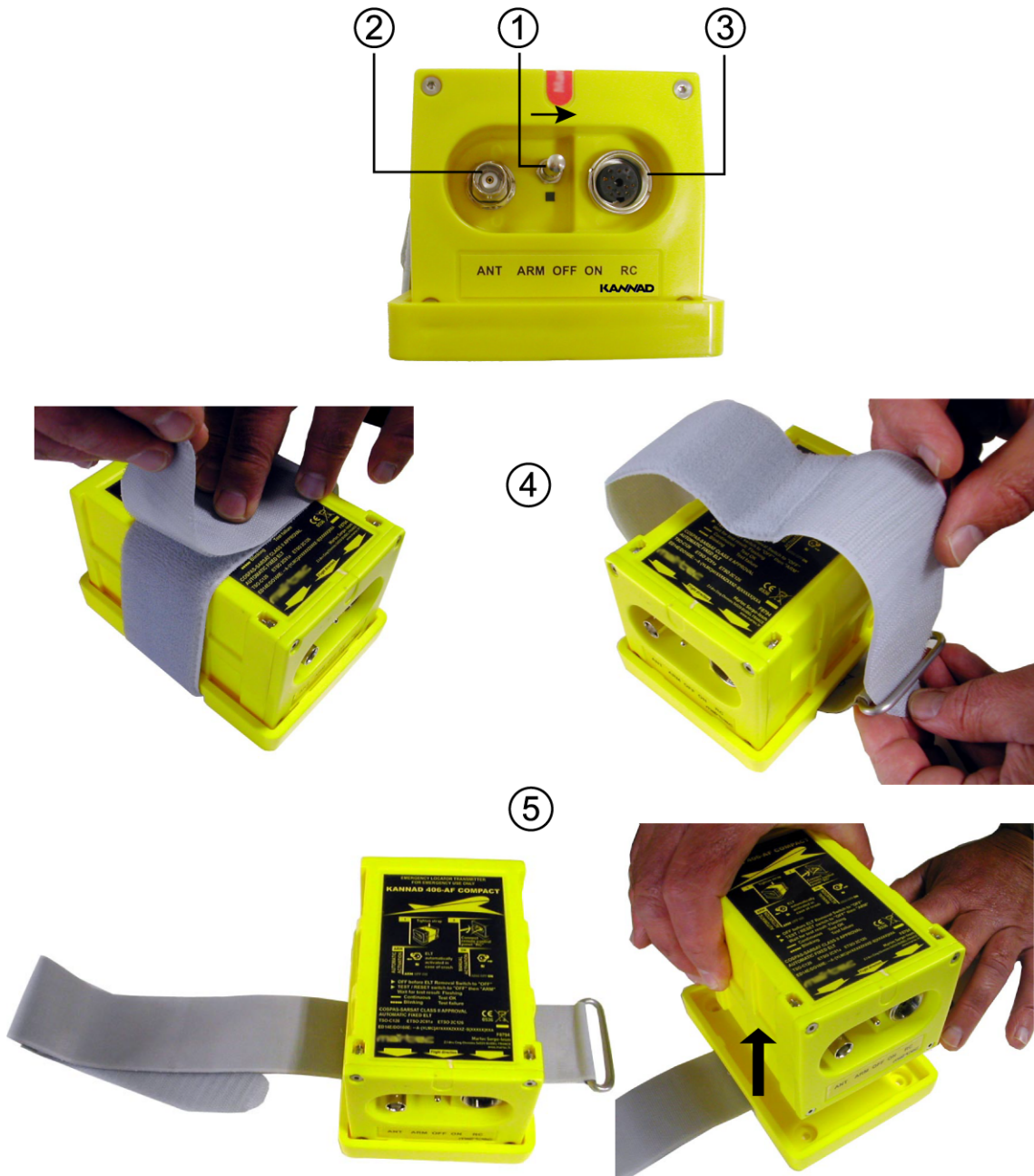

Figure 4: Removing the transmitter

PAGE INTENTIONALLY LEFT BLANK

CHECK

1. Self-test

A. Periodicity

It is recommended by the manufacturer to test the ELT to detect any possible failure.

Operational check must be performed regularly by a pilot or maintenance personnel from the cockpit (Remote Control Panel). It is recommended to perform a self-test once a month but it **should not be done more than once a week**.

Each self-test consumes energy from the battery. Should self-tests be carried out more often than the maximum allowed, the battery life-time might be shorter than specified.

B. Self-test procedure

- Check that the antenna is correctly connected
Do not perform self-test without antenna connected.
- Tune aircraft radio to 121.5 MHz and ensure you can hear it.
- Switch from position "OFF" to position "ARM" or press RESET & TEST on the Remote Control Panel (ensure that the ELT switch is in position "ARM").
- Listen for the buzzer - it operates during the whole Self-test procedure. Close to the end of self-test a short (3-4 sweeps) 121.5 transmission is made - confirm this on the aircraft radio.
- After a few seconds, the test result is displayed with the red visual indicator and the buzzer will sound:
 - One long flash indicates that the system is operational and that no error conditions were found.
 - A series of short flashes indicates the test has failed.

Remark: The number of flashes gives an indication of the faulty parameter detected during the self-test.

3+1	LOW BATTERY VOLTAGE
3+2	LOW RF POWER
3+3	FAULTY VCO LOCKING (FAULTY FREQUENCY)
3+4	NO IDENTIFICATION PROGRAMMED

If self-test fails, contact the distributor as soon as possible. Unless a waiver is granted, flight should be cancelled.

2. Operational tests

These tests must be performed by maintenance personnel when performing the first power up procedure or to check the transmitter (Refer to B. 406 and 121.5 MHz transmission test).

A. ELT operational tests

NOTE: ELT operational tests only provide the aircraft operator with an indication that the ELT is transmitting; however, a positive result cannot be interpreted as meaning that the ELT meets all operational parameters.

- connect the outside antenna to J2;
- switch the ELT from OFF to ARM;
- check that the Self-Test result is OK (one long flash).

B. 406 and 121.5 MHz transmission test

NOTE: Transmissions tests only provide the aircraft operator with an indication that the ELT is transmitting; however, a positive result cannot be interpreted as meaning that the ELT meets all operational parameters.

(1) 406 MHz

This test must be carried out with a COSPAS-SARSAT decoder.

- Perform self-test (switch ELT from OFF to ARM).
- Check with the COSPAS-SARSAT decoder that, except for the 5th and the 6th digits, the decoded message is identical to the programmed message.

NOTE: The message transmitted during self-test sequence always begins with FF FE D0 whereas a programmed message begins with FF FE 2F.

Example of message programmed in ELT:

FF FE 2F 53 C3 24 97 38 0B A6 0F D0 F5 20

Example of same message decoded by Cospas-Sarsat Decoder:

FF FE D0 53 C3 24 97 38 0B A6 0F D0 F5 20

(2) 121.5 MHz

This check shall only be conducted during the first five minutes of any UTC, (co-ordinated universal time) hour, and restricted in duration to not more than five seconds. Be sure to notify any nearby control tower of your intentions.

This test must be carried out with a VHF receiver (Aircraft VHF receiver may be used).

- Tune VHF receiver to 121.5 MHz;
- Start transmission:
 - Switch ELT to ON.
- Only 2 "sweep tones" are heard after 5 seconds, then the 121.5 MHz stops.
- Stop transmission:
 - Switch to OFF;
 - continue to listen to 121.5 MHz for a few seconds to ensure that the ELT does not continue to transmit after the test is terminated.

IMPORTANT: If the ELT operates for approximately 50 seconds, a 406 MHz signal is transmitted and is considered valid by the satellite system.

- Switch ELT to ARM.

PAGE INTENTIONALLY LEFT BLANK

TROUBLESHOOTING

1. General

Procedure for fault isolation onboard uses the indicator light (red visual indicator) of the ELT's front panel. This indicator light is activated by a self-test capability within the ELT.

2. Faults on Self-test

A. Visual Indicator

When the self-test is carried out, the number of flashes gives an indication of the faulty parameter detected during the self-test.

(1) 3+1 flashes

- Low battery voltage:
Replace battery: refer to CMM 25-63-03 for tests and repair.

(2) 3+2 flashes

- Low RF power:
Check 406 MHz power: refer to CMM 25-63-03 for tests and repair.

(3) 3+3 flashes

- Faulty VCO locking (faulty frequency):
Check frequencies: refer to CMM 25-63-03 for tests and repair.

(4) 3+4 flashes

- No identification programmed
Check programming: refer to CMM 25-63-03 for tests and repair.

PAGE INTENTIONALLY LEFT BLANK

SCHEMATICS & DIAGRAMS

1. ELT Outline Dimensions

Note: all dimensions are in millimeters
(inches in brackets)

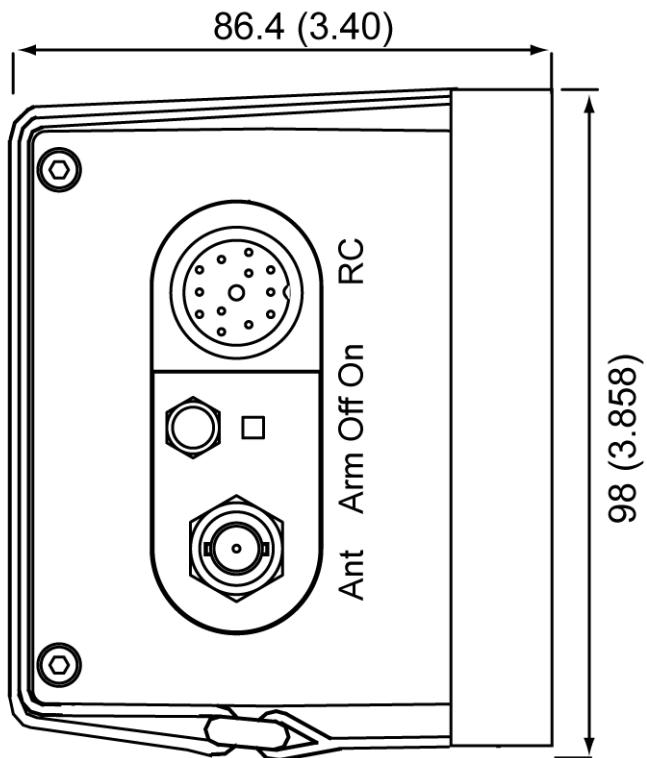
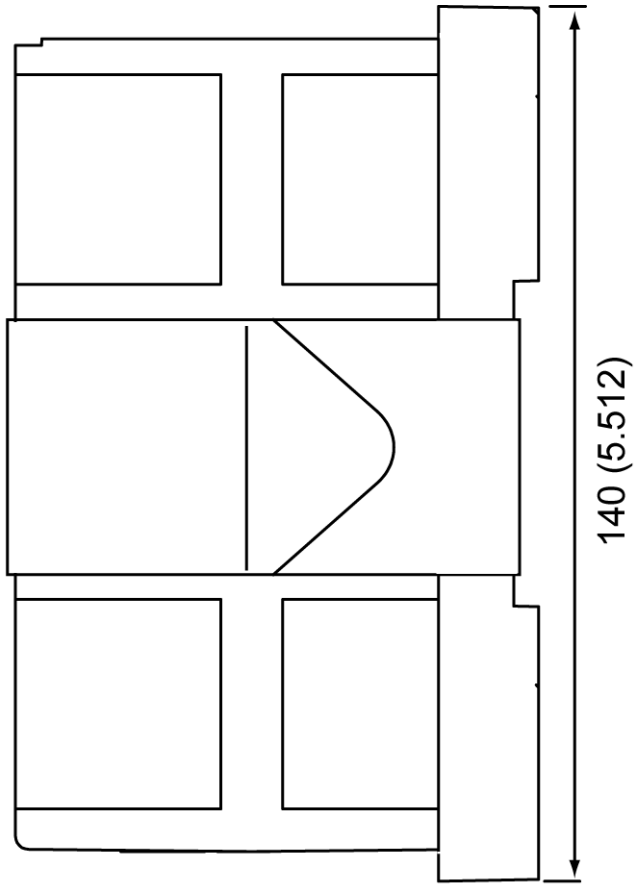

SERVICING

1. Maintenance Schedule

Battery replacement:

carried out by an accredited PART 145 or FAR 145 (or equivalent) maintenance station.

Periodic inspection:

depending if the ELT is opened or not, PART 145 or FAR 145 (or equivalent) may be required. Refer to local regulations

IMPORTANT: Inspections must be recorded on the ELT LOG SHEET (ref. DIM08013) supplied with the ELT, fields Periodic Inspection log page 2/2.

A. Periodic inspection

Note: (if required by the relevant Civil Aviation Authority).

Some Civil Aviation Authorities may require the ELT be tested periodically⁽¹⁾. In this case, it is recommended to check the following parameters:

- Proper installation.
- Operation of the controls and crash sensor.
- Transmitted signals.
- Battery corrosion.

Note: Due to the technology used for our beacon and battery pack, any corrossions between two battery replacements is unlikely to happen.

However if this inspection is required by Civil Aviation Authority, this check is detailed in CMM 25-63-03 page block CHECK page 5001.

Note (1): As indicated in the Canadian operating rule, Standard 625 "... the ELT shall be checked at intervals not exceeding 12 months, in accordance with Appendix G of Chapter 571 of the Airworthiness Manual..".

(1) Proper installation

- Remove ELT from its mounting bracket: [Refer to § 6. Removal, page 207](#)
- Inspect the mounting bracket and the ELT: Ensure the mounting bracket and the ELT are free of cracks or other obvious damage.
- Inspect the connection: Visually inspect all connector pins.

(2) Operation of the control crash sensor

- Refer to CMM 25-63-03 page block TESTING AND FAULT ISOLATION, TASK 25-63-03-700-801-01 (Beacon operating tests).

(3) Transmitted signals

- Refer to CMM 25-63-03 page block TESTING AND FAULT ISOLATION, TASK 25-63-03-700-801-01 (Beacon operating tests) or [Refer to B. 406 and 121.5 MHz transmission test, page 302.](#)

(4) Batteries corrosion

- Refer to CMM 25-63-03 page block CHECK, TASK 25-63-03-700-801-01 (Beacon operating tests)

(5) Check of 121.5 MHz frequency

- Re-install the ELT
[Refer to § 3. ELT transmitter installation procedure, page 204.](#)
- Check 121.5 MHz frequency using the aircraft tune receiver.
[Refer to § B. 406 and 121.5 MHz transmission test, page 302.](#)

B. 6-year inspection

Replacement of battery pack is mandatory every 6 years ([Refer to § 2. Battery replacement requirements, page 604.](#)).

Testing of the following elements and parameters of the ELT is mandatory every 6 years together with the battery pack replacement.

- Visual control of the housing and accessories
- Operation of the controls and crash sensor
- Measurement of 406 and 121.5 MHz output power and frequencies.
- Verification of digital message (coding).

6-year inspection must be performed in the order listed below.

(1) Visual control of the housing and accessories

- Remove ELT from its mounting bracket.
[Refer to § 6. Removal, page 207](#)
- Inspect the mounting bracket and the ELT.
 Ensure the mounting bracket and the ELT are free of cracks or other obvious damage.
- Inspect the connection.
- Visually inspect all connector pins.

(2) Operation of the controls and crash sensor

Refer to CMM 25-63-03 page block TESTING AND FAULT ISOLATION, TASK 25-63-03-700-801-01 (Beacon operating tests).

(3) Measurement of output powers, frequencies and verification of digital message

Refer to CMM 25-63-03 page block TESTING AND FAULT ISOLATION, TASK 25-63-03-700-801-01 (Beacon operating tests).

(4) Current draw measurement in ARM and ON positions (optional)

This test is required by Canadian Regulation according to CAR571, Appendix G (c)(3)(d): Refer to CMM 25-63-03 page block TESTING AND FAULT ISOLATION, TASK 25-63-03-700-801-01 (Beacon operating tests).

(5) Battery pack replacement

CAUTION: USE ONLY ORIGINAL AND APPROVED BATTERY PACK (see [2. Battery replacement requirements](#)).

Refer to CMM 25-63-03 page block DISASSEMBLY, TASK 25-63-03-000-801-A01 and page block ASSEMBLY, TASK 25-63-03-400-802-A01

(6) Check of 121.5 MHz frequency

- Re-install the ELT
[Refer to § 3. ELT transmitter installation procedure, page 204.](#)
- Check 121.5 MHz frequency using the aircraft tune receiver.
[Refer to § B. 406 and 121.5 MHz transmission test, page 302.](#)

2. Battery replacement requirements

Battery replacement is mandatory:

- after more than 1 hour of real transmission (cumulated duration);
- before or on the battery expiration date;
- after use in an emergency;
- after an inadvertant activation of unknown duration.

Only original and approved battery pack included in battery KIT BAT200 (P/N S1840510-01) supplied by KANNAD can be installed. [SAFT-FRIWO , Lithium Manganese Dioxide, 2 x M20 (D-type) cells]

PLEASE CONTACT YOUR LOCAL DISTRIBUTOR

KANNAD refuse all responsibility and invalidate all warranty should other packs be installed.

Battery available from any KANNAD distributor or dealer.

List of distributor available on our Web site: <http://www.kannad.com>

KANNAD

Z.I. des Cinq Chemins BP23

56520 GUIDEL - FRANCE

Telephone: +33 (0)2 97 02 49 49 Fax: +33 (0)2 97 65 00 20

Web: <http://www.kannad.com> - E-mail: contact.aviation@kannad.com

Support: support.sar@kannad.com Tel.: +33 (0)2 97 02 49 00

Distributed by

Manufactured by

The logo for KANNAD features the word 'KANNAD' in a bold, sans-serif font. The letters 'KAN' are dark blue, and the letters 'NAD' are yellow. The letters are closely spaced and have a slight shadow effect.

KANNAD

Z.I. des Cinq Chemins BP23

56520 GUIDEL - FRANCE

Tél. / Phone : +33 (0) 2 97 02 49 49

Fax : +33 (0) 2 97 65 00 20

DOC08038D

Ref: 0145599D